

Name:

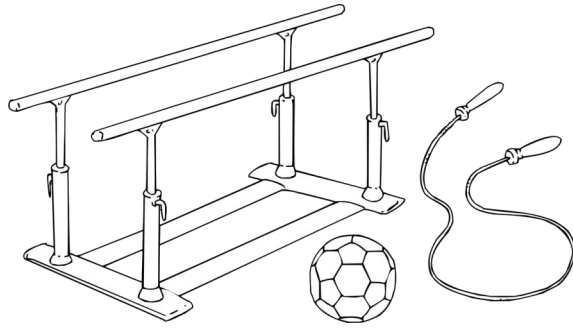
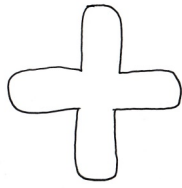

mit ZÜ!

Wir trainieren
plus bis 20

Frau Locke

Name:

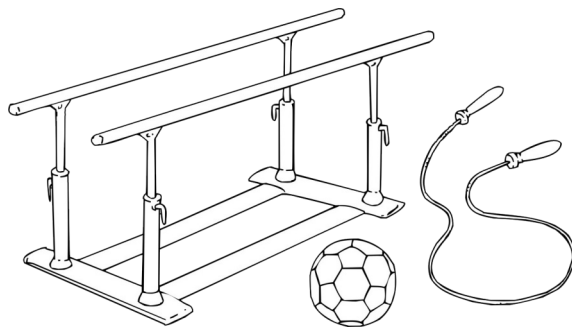
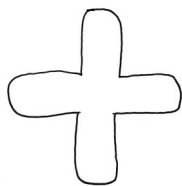

mit ZÜ!

Wir trainieren
plus bis 20

Frau Locke

$11 + 1 = \underline{\quad}$

$15 + 1 = \underline{\quad}$

$17 + 3 = \underline{\quad}$

$14 + 2 = \underline{\quad}$

$12 + 6 = \underline{\quad}$

$16 + 1 = \underline{\quad}$

$11 + 8 = \underline{\quad}$

$11 + 4 = \underline{\quad}$

$12 + 2 = \underline{\quad}$

$10 + 4 = \underline{\quad}$

$14 + 3 = \underline{\quad}$

$16 + 3 = \underline{\quad}$

$17 + 2 = \underline{\quad}$

$18 + 1 = \underline{\quad}$

$17 + 1 = \underline{\quad}$

$12 + 4 = \underline{\quad}$

$10 + 3 = \underline{\quad}$

$11 + 6 = \underline{\quad}$

$12 + 1 = \underline{\quad}$

$14 + 4 = \underline{\quad}$

$11 + 5 = \underline{\quad}$

$19 + 1 = \underline{\quad}$

$16 + 4 = \underline{\quad}$

$16 + 2 = \underline{\quad}$

$10 + 5 = \underline{\quad}$

$18 + 2 = \underline{\quad}$

$10 + 7 = \underline{\quad}$

$13 + 7 = \underline{\quad}$

$13 + 5 = \underline{\quad}$

$12 + 7 = \underline{\quad}$

$11 + 1 = \underline{\quad}$

$15 + 1 = \underline{\quad}$

$17 + 3 = \underline{\quad}$

$14 + 2 = \underline{\quad}$

$12 + 6 = \underline{\quad}$

$16 + 1 = \underline{\quad}$

$11 + 8 = \underline{\quad}$

$11 + 4 = \underline{\quad}$

$12 + 2 = \underline{\quad}$

$10 + 4 = \underline{\quad}$

$14 + 3 = \underline{\quad}$

$16 + 3 = \underline{\quad}$

$17 + 2 = \underline{\quad}$

$18 + 1 = \underline{\quad}$

$17 + 1 = \underline{\quad}$

$12 + 4 = \underline{\quad}$

$10 + 3 = \underline{\quad}$

$11 + 6 = \underline{\quad}$

$12 + 1 = \underline{\quad}$

$14 + 4 = \underline{\quad}$

$11 + 5 = \underline{\quad}$

$19 + 1 = \underline{\quad}$

$16 + 4 = \underline{\quad}$

$16 + 2 = \underline{\quad}$

$10 + 5 = \underline{\quad}$

$18 + 2 = \underline{\quad}$

$10 + 7 = \underline{\quad}$

$13 + 7 = \underline{\quad}$

$13 + 5 = \underline{\quad}$

$12 + 7 = \underline{\quad}$



$10 + 9 = \underline{\quad}$

$18 + 1 = \underline{\quad}$

$13 + 4 = \underline{\quad}$

$17 + 1 = \underline{\quad}$

$14 + 4 = \underline{\quad}$

$15 + 2 = \underline{\quad}$

$19 + 1 = \underline{\quad}$

$16 + 2 = \underline{\quad}$

$12 + 7 = \underline{\quad}$

$14 + 5 = \underline{\quad}$

$10 + 6 = \underline{\quad}$

$16 + 1 = \underline{\quad}$

$10 + 10 = \underline{\quad}$

$15 + 1 = \underline{\quad}$

$14 + 1 = \underline{\quad}$

$17 + 3 = \underline{\quad}$

$10 + 5 = \underline{\quad}$

$11 + 7 = \underline{\quad}$

$15 + 3 = \underline{\quad}$

$13 + 3 = \underline{\quad}$

$11 + 3 = \underline{\quad}$

$13 + 7 = \underline{\quad}$

$13 + 5 = \underline{\quad}$

$13 + 1 = \underline{\quad}$

$17 + 2 = \underline{\quad}$

$16 + 4 = \underline{\quad}$

$15 + 4 = \underline{\quad}$

$13 + 6 = \underline{\quad}$

$13 + 2 = \underline{\quad}$

$10 + 2 = \underline{\quad}$



$10 + 9 = \underline{\quad}$

$18 + 1 = \underline{\quad}$

$13 + 4 = \underline{\quad}$

$17 + 1 = \underline{\quad}$

$14 + 4 = \underline{\quad}$

$15 + 2 = \underline{\quad}$

$19 + 1 = \underline{\quad}$

$16 + 2 = \underline{\quad}$

$12 + 7 = \underline{\quad}$

$14 + 5 = \underline{\quad}$

$10 + 6 = \underline{\quad}$

$16 + 1 = \underline{\quad}$

$10 + 10 = \underline{\quad}$

$15 + 1 = \underline{\quad}$

$14 + 1 = \underline{\quad}$

$17 + 3 = \underline{\quad}$

$10 + 5 = \underline{\quad}$

$11 + 7 = \underline{\quad}$

$15 + 3 = \underline{\quad}$

$13 + 3 = \underline{\quad}$

$11 + 3 = \underline{\quad}$

$13 + 7 = \underline{\quad}$

$13 + 5 = \underline{\quad}$

$13 + 1 = \underline{\quad}$

$17 + 2 = \underline{\quad}$

$16 + 4 = \underline{\quad}$

$15 + 4 = \underline{\quad}$

$13 + 6 = \underline{\quad}$

$13 + 2 = \underline{\quad}$

$10 + 2 = \underline{\quad}$

$8 + 6 = \underline{\quad}$

$7 + 7 = \underline{\quad}$

$3 + 8 = \underline{\quad}$

$5 + 7 = \underline{\quad}$

$6 + 8 = \underline{\quad}$

$9 + 5 = \underline{\quad}$

$9 + 7 = \underline{\quad}$

$6 + 6 = \underline{\quad}$

$9 + 8 = \underline{\quad}$

$3 + 9 = \underline{\quad}$

$4 + 8 = \underline{\quad}$

$5 + 9 = \underline{\quad}$

$4 + 9 = \underline{\quad}$

$8 + 5 = \underline{\quad}$

$6 + 9 = \underline{\quad}$

$7 + 5 = \underline{\quad}$

$2 + 9 = \underline{\quad}$

$6 + 7 = \underline{\quad}$

$5 + 6 = \underline{\quad}$

$8 + 3 = \underline{\quad}$

$6 + 5 = \underline{\quad}$

$9 + 2 = \underline{\quad}$

$4 + 7 = \underline{\quad}$

$5 + 8 = \underline{\quad}$

$8 + 7 = \underline{\quad}$

$8 + 9 = \underline{\quad}$

$9 + 4 = \underline{\quad}$

$7 + 8 = \underline{\quad}$

$7 + 6 = \underline{\quad}$

$7 + 9 = \underline{\quad}$

$8 + 6 = \underline{\quad}$

$7 + 7 = \underline{\quad}$

$3 + 8 = \underline{\quad}$

$5 + 7 = \underline{\quad}$

$6 + 8 = \underline{\quad}$

$9 + 5 = \underline{\quad}$

$9 + 7 = \underline{\quad}$

$6 + 6 = \underline{\quad}$

$9 + 8 = \underline{\quad}$

$3 + 9 = \underline{\quad}$

$4 + 8 = \underline{\quad}$

$5 + 9 = \underline{\quad}$

$4 + 9 = \underline{\quad}$

$8 + 5 = \underline{\quad}$

$6 + 9 = \underline{\quad}$

$7 + 5 = \underline{\quad}$

$2 + 9 = \underline{\quad}$

$6 + 7 = \underline{\quad}$

$5 + 6 = \underline{\quad}$

$8 + 3 = \underline{\quad}$

$6 + 5 = \underline{\quad}$

$9 + 2 = \underline{\quad}$

$4 + 7 = \underline{\quad}$

$5 + 8 = \underline{\quad}$

$8 + 7 = \underline{\quad}$

$8 + 9 = \underline{\quad}$

$9 + 4 = \underline{\quad}$

$7 + 8 = \underline{\quad}$

$7 + 6 = \underline{\quad}$

$7 + 9 = \underline{\quad}$



$8 + 4 = \underline{\quad}$

$9 + 4 = \underline{\quad}$

$4 + 7 = \underline{\quad}$

$4 + 9 = \underline{\quad}$

$8 + 5 = \underline{\quad}$

$7 + 4 = \underline{\quad}$

$2 + 9 = \underline{\quad}$

$8 + 6 = \underline{\quad}$

$4 + 8 = \underline{\quad}$

$5 + 8 = \underline{\quad}$

$6 + 6 = \underline{\quad}$

$3 + 9 = \underline{\quad}$

$5 + 9 = \underline{\quad}$

$8 + 3 = \underline{\quad}$

$5 + 6 = \underline{\quad}$

$6 + 8 = \underline{\quad}$

$7 + 7 = \underline{\quad}$

$9 + 3 = \underline{\quad}$

$9 + 2 = \underline{\quad}$

$9 + 6 = \underline{\quad}$

$7 + 9 = \underline{\quad}$

$6 + 7 = \underline{\quad}$

$3 + 8 = \underline{\quad}$

$9 + 9 = \underline{\quad}$

$6 + 9 = \underline{\quad}$

$5 + 7 = \underline{\quad}$

$7 + 6 = \underline{\quad}$

$8 + 7 = \underline{\quad}$

$6 + 5 = \underline{\quad}$

$8 + 8 = \underline{\quad}$



$8 + 4 = \underline{\quad}$

$9 + 4 = \underline{\quad}$

$4 + 7 = \underline{\quad}$

$4 + 9 = \underline{\quad}$

$8 + 5 = \underline{\quad}$

$7 + 4 = \underline{\quad}$

$2 + 9 = \underline{\quad}$

$8 + 6 = \underline{\quad}$

$4 + 8 = \underline{\quad}$

$5 + 8 = \underline{\quad}$

$6 + 6 = \underline{\quad}$

$3 + 9 = \underline{\quad}$

$5 + 9 = \underline{\quad}$

$8 + 3 = \underline{\quad}$

$5 + 6 = \underline{\quad}$

$6 + 8 = \underline{\quad}$

$7 + 7 = \underline{\quad}$

$9 + 3 = \underline{\quad}$

$9 + 2 = \underline{\quad}$

$9 + 6 = \underline{\quad}$

$7 + 9 = \underline{\quad}$

$6 + 7 = \underline{\quad}$

$3 + 8 = \underline{\quad}$

$9 + 9 = \underline{\quad}$

$6 + 9 = \underline{\quad}$

$5 + 7 = \underline{\quad}$

$7 + 6 = \underline{\quad}$

$8 + 7 = \underline{\quad}$

$6 + 5 = \underline{\quad}$

$8 + 8 = \underline{\quad}$



$5 + 7 = \underline{\quad}$

$9 + 7 = \underline{\quad}$

$6 + 6 = \underline{\quad}$

$5 + 6 = \underline{\quad}$

$8 + 6 = \underline{\quad}$

$9 + 6 = \underline{\quad}$

$7 + 5 = \underline{\quad}$

$4 + 8 = \underline{\quad}$

$9 + 2 = \underline{\quad}$

$2 + 9 = \underline{\quad}$

$6 + 5 = \underline{\quad}$

$6 + 8 = \underline{\quad}$

$7 + 7 = \underline{\quad}$

$8 + 7 = \underline{\quad}$

$7 + 6 = \underline{\quad}$

$4 + 7 = \underline{\quad}$

$4 + 9 = \underline{\quad}$

$8 + 8 = \underline{\quad}$

$5 + 9 = \underline{\quad}$

$7 + 8 = \underline{\quad}$

$9 + 4 = \underline{\quad}$

$3 + 8 = \underline{\quad}$

$3 + 9 = \underline{\quad}$

$9 + 3 = \underline{\quad}$

$8 + 5 = \underline{\quad}$

$7 + 4 = \underline{\quad}$

$5 + 8 = \underline{\quad}$

$6 + 7 = \underline{\quad}$

$7 + 9 = \underline{\quad}$

$6 + 9 = \underline{\quad}$



$5 + 7 = \underline{\quad}$

$9 + 7 = \underline{\quad}$

$6 + 6 = \underline{\quad}$

$5 + 6 = \underline{\quad}$

$8 + 6 = \underline{\quad}$

$9 + 6 = \underline{\quad}$

$7 + 5 = \underline{\quad}$

$4 + 8 = \underline{\quad}$

$9 + 2 = \underline{\quad}$

$2 + 9 = \underline{\quad}$

$6 + 5 = \underline{\quad}$

$6 + 8 = \underline{\quad}$

$7 + 7 = \underline{\quad}$

$8 + 7 = \underline{\quad}$

$7 + 6 = \underline{\quad}$

$4 + 7 = \underline{\quad}$

$4 + 9 = \underline{\quad}$

$8 + 8 = \underline{\quad}$

$5 + 9 = \underline{\quad}$

$7 + 8 = \underline{\quad}$

$9 + 4 = \underline{\quad}$

$3 + 8 = \underline{\quad}$

$3 + 9 = \underline{\quad}$

$9 + 3 = \underline{\quad}$

$8 + 5 = \underline{\quad}$

$7 + 4 = \underline{\quad}$

$5 + 8 = \underline{\quad}$

$6 + 7 = \underline{\quad}$

$7 + 9 = \underline{\quad}$

$6 + 9 = \underline{\quad}$



$16 + 4 = \underline{\quad}$

$5 + 10 = \underline{\quad}$

$2 + 1 = \underline{\quad}$

$6 + 14 = \underline{\quad}$

$10 + 1 = \underline{\quad}$

$1 + 8 = \underline{\quad}$

$4 + 3 = \underline{\quad}$

$14 + 5 = \underline{\quad}$

$13 + 4 = \underline{\quad}$

$11 + 6 = \underline{\quad}$

$12 + 6 = \underline{\quad}$

$13 + 1 = \underline{\quad}$

$2 + 13 = \underline{\quad}$

$11 + 5 = \underline{\quad}$

$9 + 4 = \underline{\quad}$

$17 + 2 = \underline{\quad}$

$2 + 18 = \underline{\quad}$

$2 + 7 = \underline{\quad}$

$15 + 2 = \underline{\quad}$

$16 + 2 = \underline{\quad}$

$8 + 3 = \underline{\quad}$

$9 + 2 = \underline{\quad}$

$17 + 1 = \underline{\quad}$

$3 + 7 = \underline{\quad}$

$13 + 5 = \underline{\quad}$

$14 + 1 = \underline{\quad}$

$4 + 12 = \underline{\quad}$

$1 + 4 = \underline{\quad}$

$7 + 6 = \underline{\quad}$

$2 + 10 = \underline{\quad}$



$16 + 4 = \underline{\quad}$

$5 + 10 = \underline{\quad}$

$2 + 1 = \underline{\quad}$

$6 + 14 = \underline{\quad}$

$10 + 1 = \underline{\quad}$

$1 + 8 = \underline{\quad}$

$4 + 3 = \underline{\quad}$

$14 + 5 = \underline{\quad}$

$13 + 4 = \underline{\quad}$

$11 + 6 = \underline{\quad}$

$12 + 6 = \underline{\quad}$

$13 + 1 = \underline{\quad}$

$2 + 13 = \underline{\quad}$

$11 + 5 = \underline{\quad}$

$9 + 4 = \underline{\quad}$

$17 + 2 = \underline{\quad}$

$2 + 18 = \underline{\quad}$

$2 + 7 = \underline{\quad}$

$15 + 2 = \underline{\quad}$

$16 + 2 = \underline{\quad}$

$8 + 3 = \underline{\quad}$

$9 + 2 = \underline{\quad}$

$17 + 1 = \underline{\quad}$

$3 + 7 = \underline{\quad}$

$13 + 5 = \underline{\quad}$

$14 + 1 = \underline{\quad}$

$4 + 12 = \underline{\quad}$

$1 + 4 = \underline{\quad}$

$7 + 6 = \underline{\quad}$

$2 + 10 = \underline{\quad}$



$2 + 13 = \underline{\quad}$

$4 + 1 = \underline{\quad}$

$1 + 12 = \underline{\quad}$

$12 + 4 = \underline{\quad}$

$1 + 10 = \underline{\quad}$

$13 + 6 = \underline{\quad}$

$16 + 2 = \underline{\quad}$

$11 + 7 = \underline{\quad}$

$10 + 1 = \underline{\quad}$

$2 + 3 = \underline{\quad}$

$7 + 13 = \underline{\quad}$

$6 + 10 = \underline{\quad}$

$9 + 8 = \underline{\quad}$

$2 + 18 = \underline{\quad}$

$3 + 1 = \underline{\quad}$

$12 + 3 = \underline{\quad}$

$2 + 17 = \underline{\quad}$

$5 + 14 = \underline{\quad}$

$11 + 6 = \underline{\quad}$

$6 + 5 = \underline{\quad}$

$16 + 1 = \underline{\quad}$

$10 + 10 = \underline{\quad}$

$12 + 2 = \underline{\quad}$

$3 + 17 = \underline{\quad}$

$17 + 2 = \underline{\quad}$

$14 + 1 = \underline{\quad}$

$15 + 2 = \underline{\quad}$

$17 + 1 = \underline{\quad}$

$3 + 14 = \underline{\quad}$

$12 + 5 = \underline{\quad}$



$2 + 13 = \underline{\quad}$

$4 + 1 = \underline{\quad}$

$1 + 12 = \underline{\quad}$

$12 + 4 = \underline{\quad}$

$1 + 10 = \underline{\quad}$

$13 + 6 = \underline{\quad}$

$16 + 2 = \underline{\quad}$

$11 + 7 = \underline{\quad}$

$10 + 1 = \underline{\quad}$

$2 + 3 = \underline{\quad}$

$7 + 13 = \underline{\quad}$

$6 + 10 = \underline{\quad}$

$9 + 8 = \underline{\quad}$

$2 + 18 = \underline{\quad}$

$3 + 1 = \underline{\quad}$

$12 + 3 = \underline{\quad}$

$2 + 17 = \underline{\quad}$

$5 + 14 = \underline{\quad}$

$11 + 6 = \underline{\quad}$

$6 + 5 = \underline{\quad}$

$16 + 1 = \underline{\quad}$

$10 + 10 = \underline{\quad}$

$12 + 2 = \underline{\quad}$

$3 + 17 = \underline{\quad}$

$17 + 2 = \underline{\quad}$

$14 + 1 = \underline{\quad}$

$15 + 2 = \underline{\quad}$

$17 + 1 = \underline{\quad}$

$3 + 14 = \underline{\quad}$

$12 + 5 = \underline{\quad}$

8 

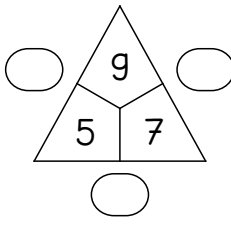
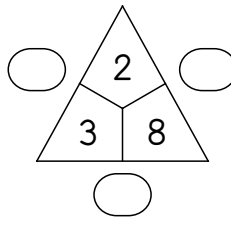
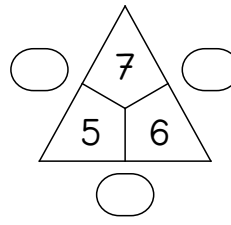
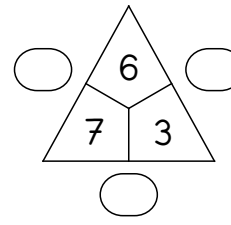
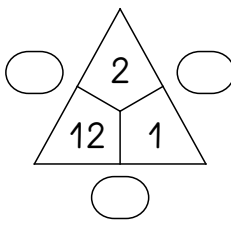
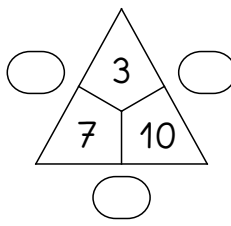
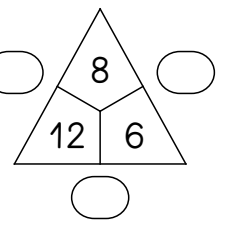
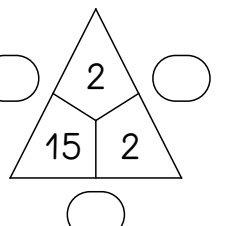
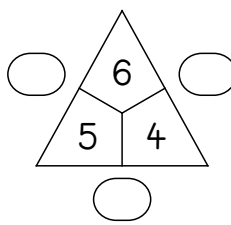
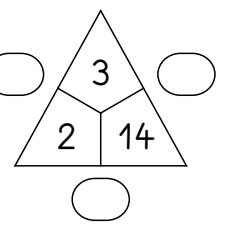
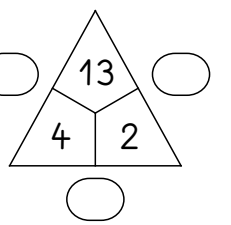
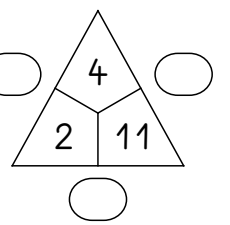
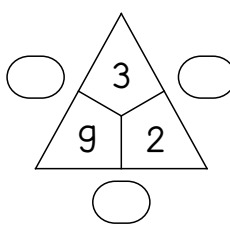
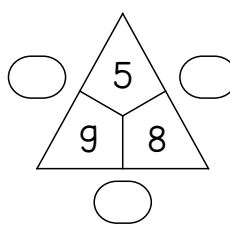
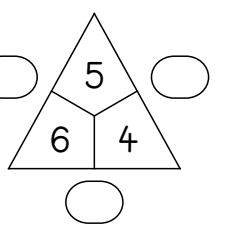
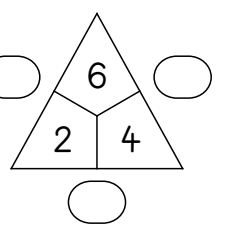
8 

9

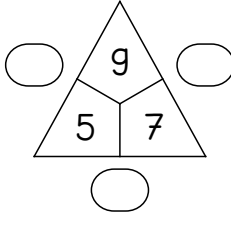
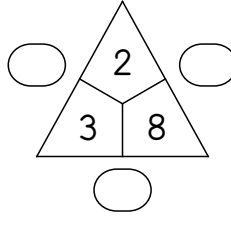
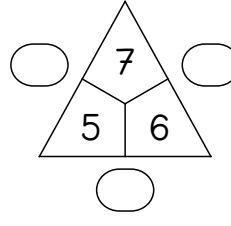
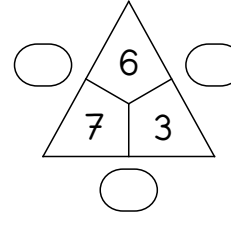
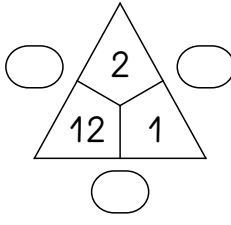
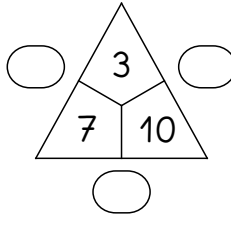
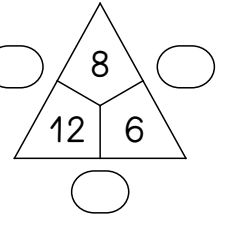
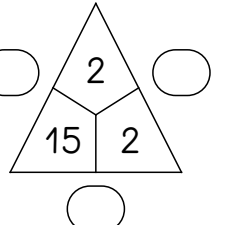
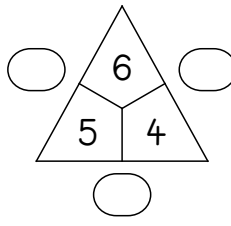
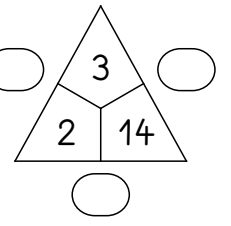
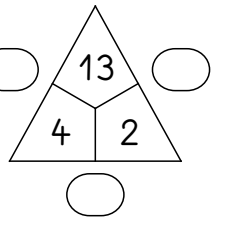
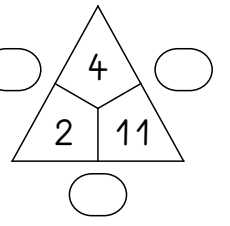
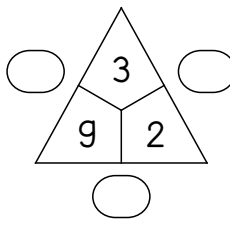
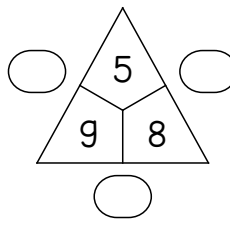
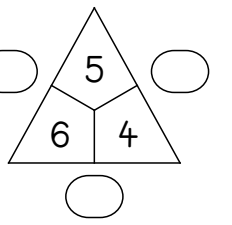
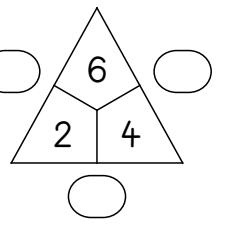

+	11	7	5	6	2
3					
9					
2					

+	6	8	7	3	2
12					
5					
2					

+	3	2	6	5	7
11					
5					
2					
13					
8					

+	3	6	9	7	5
1					
10					
7					

9





+	11	7	5	6	2
3					
9					
2					

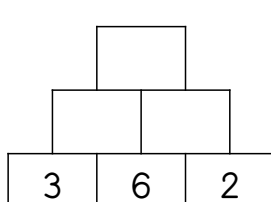
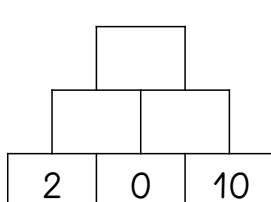
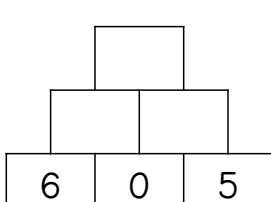
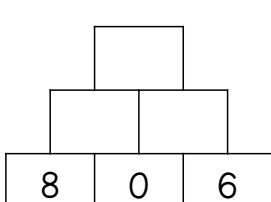
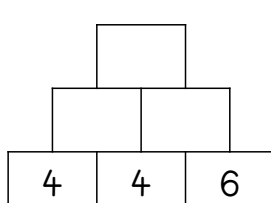
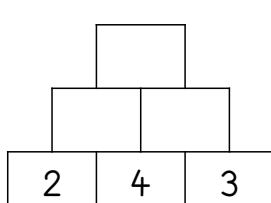
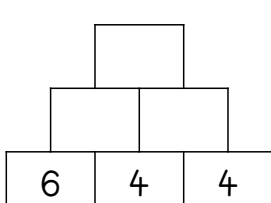
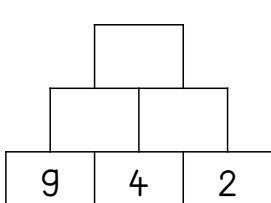
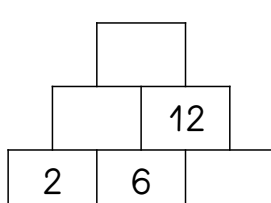
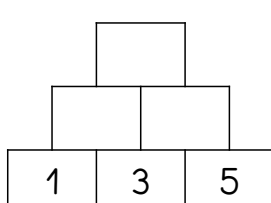
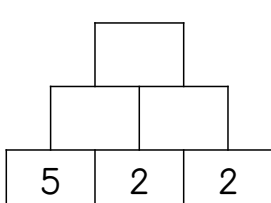
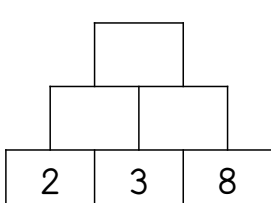
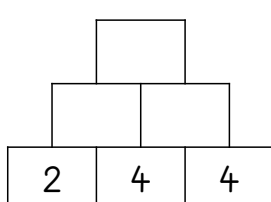
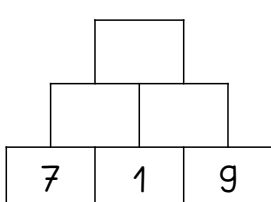
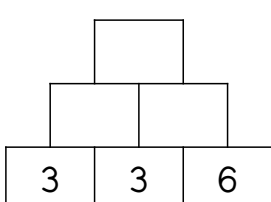
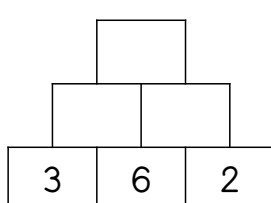
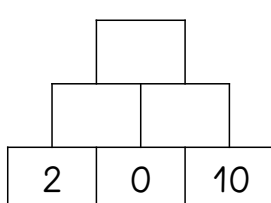
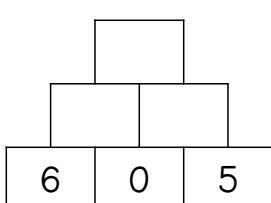
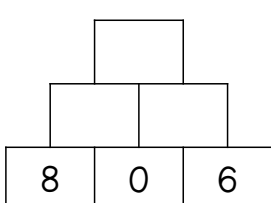
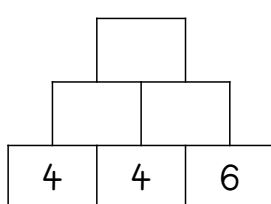
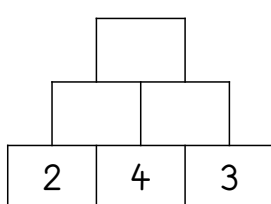
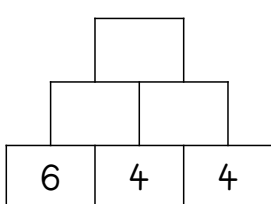
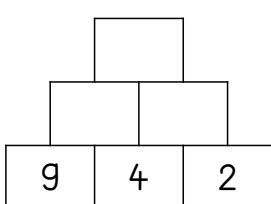
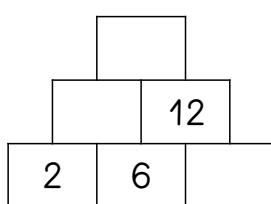
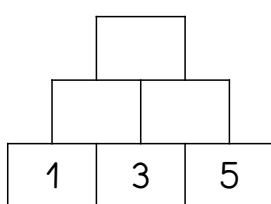
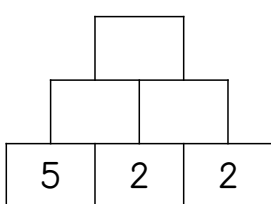
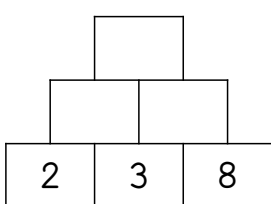
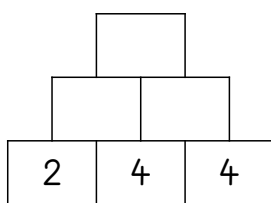
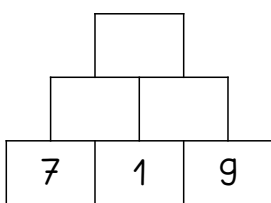
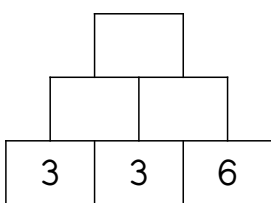

+	6	8	7	3	2
12					
5					
2					

+	3	2	6	5	7
11					
5					
2					
13					
8					

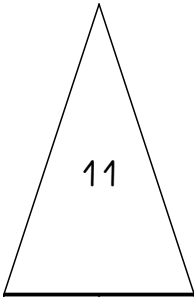
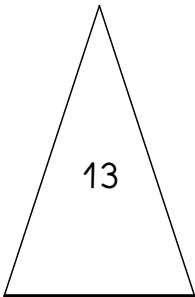
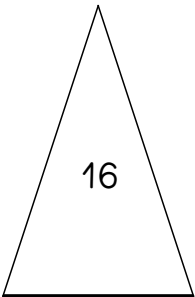
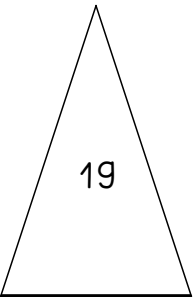
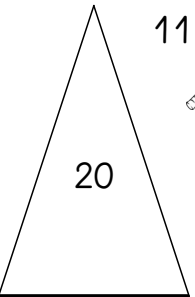
+	3	6	9	7	5
1					
10					
7					

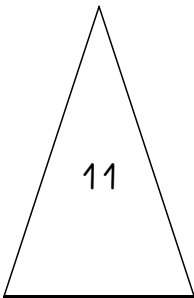
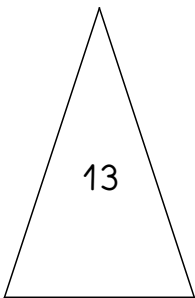
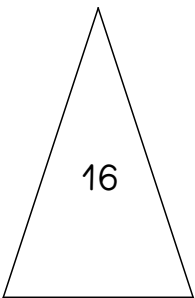
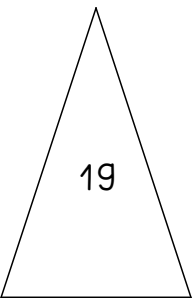
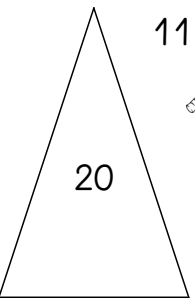

					11 																																																																																																				
<table border="1" style="width: 100%; border-collapse: collapse;"><tr><td>4</td><td></td></tr><tr><td>8</td><td></td></tr><tr><td>11</td><td></td></tr><tr><td>7</td><td></td></tr><tr><td>9</td><td></td></tr><tr><td>0</td><td></td></tr><tr><td>10</td><td></td></tr><tr><td>1</td><td></td></tr><tr><td>6</td><td></td></tr><tr><td>2</td><td></td></tr></table>	4		8		11		7		9		0		10		1		6		2		<table border="1" style="width: 100%; border-collapse: collapse;"><tr><td>3</td><td></td></tr><tr><td>10</td><td></td></tr><tr><td>1</td><td></td></tr><tr><td>2</td><td></td></tr><tr><td>6</td><td></td></tr><tr><td>8</td><td></td></tr><tr><td>4</td><td></td></tr><tr><td>0</td><td></td></tr><tr><td>13</td><td></td></tr><tr><td>7</td><td></td></tr></table>	3		10		1		2		6		8		4		0		13		7		<table border="1" style="width: 100%; border-collapse: collapse;"><tr><td>1</td><td></td></tr><tr><td>15</td><td></td></tr><tr><td>7</td><td></td></tr><tr><td>5</td><td></td></tr><tr><td>8</td><td></td></tr><tr><td>16</td><td></td></tr><tr><td>4</td><td></td></tr><tr><td>14</td><td></td></tr><tr><td>2</td><td></td></tr><tr><td>6</td><td></td></tr></table>	1		15		7		5		8		16		4		14		2		6		<table border="1" style="width: 100%; border-collapse: collapse;"><tr><td>15</td><td></td></tr><tr><td>1</td><td></td></tr><tr><td>6</td><td></td></tr><tr><td>14</td><td></td></tr><tr><td>9</td><td></td></tr><tr><td>17</td><td></td></tr><tr><td>5</td><td></td></tr><tr><td>12</td><td></td></tr><tr><td>11</td><td></td></tr><tr><td>7</td><td></td></tr></table>	15		1		6		14		9		17		5		12		11		7		<table border="1" style="width: 100%; border-collapse: collapse;"><tr><td>17</td><td></td></tr><tr><td>15</td><td></td></tr><tr><td>12</td><td></td></tr><tr><td>8</td><td></td></tr><tr><td>0</td><td></td></tr><tr><td>10</td><td></td></tr><tr><td>18</td><td></td></tr><tr><td>20</td><td></td></tr><tr><td>4</td><td></td></tr><tr><td>14</td><td></td></tr></table>	17		15		12		8		0		10		18		20		4		14		
4																																																																																																									
8																																																																																																									
11																																																																																																									
7																																																																																																									
9																																																																																																									
0																																																																																																									
10																																																																																																									
1																																																																																																									
6																																																																																																									
2																																																																																																									
3																																																																																																									
10																																																																																																									
1																																																																																																									
2																																																																																																									
6																																																																																																									
8																																																																																																									
4																																																																																																									
0																																																																																																									
13																																																																																																									
7																																																																																																									
1																																																																																																									
15																																																																																																									
7																																																																																																									
5																																																																																																									
8																																																																																																									
16																																																																																																									
4																																																																																																									
14																																																																																																									
2																																																																																																									
6																																																																																																									
15																																																																																																									
1																																																																																																									
6																																																																																																									
14																																																																																																									
9																																																																																																									
17																																																																																																									
5																																																																																																									
12																																																																																																									
11																																																																																																									
7																																																																																																									
17																																																																																																									
15																																																																																																									
12																																																																																																									
8																																																																																																									
0																																																																																																									
10																																																																																																									
18																																																																																																									
20																																																																																																									
4																																																																																																									
14																																																																																																									

					11 																																																																																																				
<table border="1" style="width: 100%; border-collapse: collapse;"><tr><td>4</td><td></td></tr><tr><td>8</td><td></td></tr><tr><td>11</td><td></td></tr><tr><td>7</td><td></td></tr><tr><td>9</td><td></td></tr><tr><td>0</td><td></td></tr><tr><td>10</td><td></td></tr><tr><td>1</td><td></td></tr><tr><td>6</td><td></td></tr><tr><td>2</td><td></td></tr></table>	4		8		11		7		9		0		10		1		6		2		<table border="1" style="width: 100%; border-collapse: collapse;"><tr><td>3</td><td></td></tr><tr><td>10</td><td></td></tr><tr><td>1</td><td></td></tr><tr><td>2</td><td></td></tr><tr><td>6</td><td></td></tr><tr><td>8</td><td></td></tr><tr><td>4</td><td></td></tr><tr><td>0</td><td></td></tr><tr><td>13</td><td></td></tr><tr><td>7</td><td></td></tr></table>	3		10		1		2		6		8		4		0		13		7		<table border="1" style="width: 100%; border-collapse: collapse;"><tr><td>1</td><td></td></tr><tr><td>15</td><td></td></tr><tr><td>7</td><td></td></tr><tr><td>5</td><td></td></tr><tr><td>8</td><td></td></tr><tr><td>16</td><td></td></tr><tr><td>4</td><td></td></tr><tr><td>14</td><td></td></tr><tr><td>2</td><td></td></tr><tr><td>6</td><td></td></tr></table>	1		15		7		5		8		16		4		14		2		6		<table border="1" style="width: 100%; border-collapse: collapse;"><tr><td>15</td><td></td></tr><tr><td>1</td><td></td></tr><tr><td>6</td><td></td></tr><tr><td>14</td><td></td></tr><tr><td>9</td><td></td></tr><tr><td>17</td><td></td></tr><tr><td>5</td><td></td></tr><tr><td>12</td><td></td></tr><tr><td>11</td><td></td></tr><tr><td>7</td><td></td></tr></table>	15		1		6		14		9		17		5		12		11		7		<table border="1" style="width: 100%; border-collapse: collapse;"><tr><td>17</td><td></td></tr><tr><td>15</td><td></td></tr><tr><td>12</td><td></td></tr><tr><td>8</td><td></td></tr><tr><td>0</td><td></td></tr><tr><td>10</td><td></td></tr><tr><td>18</td><td></td></tr><tr><td>20</td><td></td></tr><tr><td>4</td><td></td></tr><tr><td>14</td><td></td></tr></table>	17		15		12		8		0		10		18		20		4		14		
4																																																																																																									
8																																																																																																									
11																																																																																																									
7																																																																																																									
9																																																																																																									
0																																																																																																									
10																																																																																																									
1																																																																																																									
6																																																																																																									
2																																																																																																									
3																																																																																																									
10																																																																																																									
1																																																																																																									
2																																																																																																									
6																																																																																																									
8																																																																																																									
4																																																																																																									
0																																																																																																									
13																																																																																																									
7																																																																																																									
1																																																																																																									
15																																																																																																									
7																																																																																																									
5																																																																																																									
8																																																																																																									
16																																																																																																									
4																																																																																																									
14																																																																																																									
2																																																																																																									
6																																																																																																									
15																																																																																																									
1																																																																																																									
6																																																																																																									
14																																																																																																									
9																																																																																																									
17																																																																																																									
5																																																																																																									
12																																																																																																									
11																																																																																																									
7																																																																																																									
17																																																																																																									
15																																																																																																									
12																																																																																																									
8																																																																																																									
0																																																																																																									
10																																																																																																									
18																																																																																																									
20																																																																																																									
4																																																																																																									
14																																																																																																									



$18 + \underline{\quad} = 20$

$10 + \underline{\quad} = 18$

$17 + \underline{\quad} = 20$

$10 + \underline{\quad} = 17$

$15 + \underline{\quad} = 19$

$11 + \underline{\quad} = 15$

$19 + \underline{\quad} = 20$

$10 + \underline{\quad} = 12$

$15 + \underline{\quad} = 18$

$13 + \underline{\quad} = 15$

$12 + \underline{\quad} = 18$

$17 + \underline{\quad} = 18$

$17 + \underline{\quad} = 19$

$11 + \underline{\quad} = 20$

$13 + \underline{\quad} = 17$

$11 + \underline{\quad} = 13$

$11 + \underline{\quad} = 14$

$15 + \underline{\quad} = 17$

$13 + \underline{\quad} = 18$

$14 + \underline{\quad} = 20$

$10 + \underline{\quad} = 15$

$18 + \underline{\quad} = 19$

$12 + \underline{\quad} = 16$

$15 + \underline{\quad} = 16$

$16 + \underline{\quad} = 19$

$15 + \underline{\quad} = 20$

$14 + \underline{\quad} = 15$

$12 + \underline{\quad} = 14$

$16 + \underline{\quad} = 20$

$13 + \underline{\quad} = 20$



$18 + \underline{\quad} = 20$

$10 + \underline{\quad} = 18$

$17 + \underline{\quad} = 20$

$10 + \underline{\quad} = 17$

$15 + \underline{\quad} = 19$

$11 + \underline{\quad} = 15$

$19 + \underline{\quad} = 20$

$10 + \underline{\quad} = 12$

$15 + \underline{\quad} = 18$

$13 + \underline{\quad} = 15$

$12 + \underline{\quad} = 18$

$17 + \underline{\quad} = 18$

$17 + \underline{\quad} = 19$

$11 + \underline{\quad} = 20$

$13 + \underline{\quad} = 17$

$11 + \underline{\quad} = 13$

$11 + \underline{\quad} = 14$

$15 + \underline{\quad} = 17$

$13 + \underline{\quad} = 18$

$14 + \underline{\quad} = 20$

$10 + \underline{\quad} = 15$

$18 + \underline{\quad} = 19$

$12 + \underline{\quad} = 16$

$15 + \underline{\quad} = 16$

$16 + \underline{\quad} = 19$

$15 + \underline{\quad} = 20$

$14 + \underline{\quad} = 15$

$12 + \underline{\quad} = 14$

$16 + \underline{\quad} = 20$

$13 + \underline{\quad} = 20$

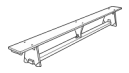

$8 + \underline{\quad} = 17$

$8 + \underline{\quad} = 13$

$9 + \underline{\quad} = 14$

$5 + \underline{\quad} = 12$

$9 + \underline{\quad} = 12$

$8 + \underline{\quad} = 11$

$2 + \underline{\quad} = 11$

$3 + \underline{\quad} = 11$

$9 + \underline{\quad} = 11$

$4 + \underline{\quad} = 11$

$6 + \underline{\quad} = 13$

$7 + \underline{\quad} = 14$

$4 + \underline{\quad} = 12$

$4 + \underline{\quad} = 13$

$9 + \underline{\quad} = 18$

$6 + \underline{\quad} = 11$

$7 + \underline{\quad} = 15$

$8 + \underline{\quad} = 15$

$8 + \underline{\quad} = 14$

$7 + \underline{\quad} = 13$

$5 + \underline{\quad} = 11$

$3 + \underline{\quad} = 12$

$6 + \underline{\quad} = 14$

$8 + \underline{\quad} = 12$

$5 + \underline{\quad} = 14$

$7 + \underline{\quad} = 16$

$7 + \underline{\quad} = 11$

$6 + \underline{\quad} = 15$

$9 + \underline{\quad} = 16$

$5 + \underline{\quad} = 13$

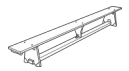

$8 + \underline{\quad} = 17$

$8 + \underline{\quad} = 13$

$9 + \underline{\quad} = 14$

$5 + \underline{\quad} = 12$

$9 + \underline{\quad} = 12$

$8 + \underline{\quad} = 11$

$2 + \underline{\quad} = 11$

$3 + \underline{\quad} = 11$

$9 + \underline{\quad} = 11$

$4 + \underline{\quad} = 11$

$6 + \underline{\quad} = 13$

$7 + \underline{\quad} = 14$

$4 + \underline{\quad} = 12$

$4 + \underline{\quad} = 13$

$9 + \underline{\quad} = 18$

$6 + \underline{\quad} = 11$

$7 + \underline{\quad} = 15$

$8 + \underline{\quad} = 15$

$8 + \underline{\quad} = 14$

$7 + \underline{\quad} = 13$

$5 + \underline{\quad} = 11$

$3 + \underline{\quad} = 12$

$6 + \underline{\quad} = 14$

$8 + \underline{\quad} = 12$

$5 + \underline{\quad} = 14$

$7 + \underline{\quad} = 16$

$7 + \underline{\quad} = 11$

$6 + \underline{\quad} = 15$

$9 + \underline{\quad} = 16$

$5 + \underline{\quad} = 13$



$12 + 5 = \underline{\quad}$

$18 + 1 = \underline{\quad}$

$12 + 6 = \underline{\quad}$

$\underline{\quad} + 7 = 18$

$\underline{\quad} + 4 = 18$

$15 + 2 = \underline{\quad}$

$17 + \underline{\quad} = 18$

$17 + \underline{\quad} = 20$

$\underline{\quad} + 7 = 19$

$19 + \underline{\quad} = 20$

$13 + 5 = \underline{\quad}$

$13 + \underline{\quad} = 16$

$12 + \underline{\quad} = 13$

$15 + 5 = \underline{\quad}$

$13 + \underline{\quad} = 20$

$\underline{\quad} + 6 = 16$

$\underline{\quad} + 4 = 20$

$15 + 1 = \underline{\quad}$

$\underline{\quad} + 4 = 19$

$14 + \underline{\quad} = 19$

$12 + 4 = \underline{\quad}$

$10 + \underline{\quad} = 17$

$\underline{\quad} + 1 = 11$

$12 + \underline{\quad} = 14$

$\underline{\quad} + 1 = 17$

$18 + 2 = \underline{\quad}$

$\underline{\quad} + 3 = 14$

$\underline{\quad} + 6 = 20$

$14 + \underline{\quad} = 16$

$15 + 3 = \underline{\quad}$

$10 + 3 = \underline{\quad}$

$\underline{\quad} + 4 = 14$

$\underline{\quad} + 3 = 17$



$12 + 5 = \underline{\quad}$

$18 + 1 = \underline{\quad}$

$12 + 6 = \underline{\quad}$

$\underline{\quad} + 7 = 18$

$\underline{\quad} + 4 = 18$

$15 + 2 = \underline{\quad}$

$17 + \underline{\quad} = 18$

$17 + \underline{\quad} = 20$

$\underline{\quad} + 7 = 19$

$19 + \underline{\quad} = 20$

$13 + 5 = \underline{\quad}$

$13 + \underline{\quad} = 16$

$12 + \underline{\quad} = 13$

$15 + 5 = \underline{\quad}$

$13 + \underline{\quad} = 20$

$\underline{\quad} + 6 = 16$

$\underline{\quad} + 4 = 20$

$15 + 1 = \underline{\quad}$

$\underline{\quad} + 4 = 19$

$14 + \underline{\quad} = 19$

$12 + 4 = \underline{\quad}$

$10 + \underline{\quad} = 17$

$\underline{\quad} + 1 = 11$

$12 + \underline{\quad} = 14$

$\underline{\quad} + 1 = 17$

$18 + 2 = \underline{\quad}$

$\underline{\quad} + 3 = 14$

$\underline{\quad} + 6 = 20$

$14 + \underline{\quad} = 16$

$15 + 3 = \underline{\quad}$

$10 + 3 = \underline{\quad}$

$\underline{\quad} + 4 = 14$

$\underline{\quad} + 3 = 17$

15

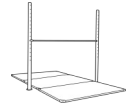

$3 + 8 = \underline{\quad}$

$\underline{\quad} + 5 = 14$

$9 + \underline{\quad} = 11$

$4 + 8 = \underline{\quad}$

$5 + 6 = \underline{\quad}$

$\underline{\quad} + 9 = 14$

$\underline{\quad} + 4 = 11$

$9 + \underline{\quad} = 18$

$6 + 5 = \underline{\quad}$

$8 + 5 = \underline{\quad}$

$\underline{\quad} + 3 = 11$

$7 + \underline{\quad} = 15$

$4 + \underline{\quad} = 13$

$\underline{\quad} + 7 = 16$

$7 + 6 = \underline{\quad}$

$3 + 9 = \underline{\quad}$

$9 + \underline{\quad} = 17$

$6 + 6 = \underline{\quad}$

$8 + \underline{\quad} = 16$

$\underline{\quad} + 9 = 15$

$9 + 6 = \underline{\quad}$

$2 + \underline{\quad} = 11$

$8 + \underline{\quad} = 14$

$\underline{\quad} + 7 = 14$

$\underline{\quad} + 9 = 16$

$9 + \underline{\quad} = 12$

$4 + \underline{\quad} = 11$

$8 + 4 = \underline{\quad}$

$6 + \underline{\quad} = 13$

$9 + \underline{\quad} = 13$

15



$3 + 8 = \underline{\quad}$

$\underline{\quad} + 5 = 14$

$9 + \underline{\quad} = 11$

$4 + 8 = \underline{\quad}$

$5 + 6 = \underline{\quad}$

$\underline{\quad} + 9 = 14$

$\underline{\quad} + 4 = 11$

$9 + \underline{\quad} = 18$

$6 + 5 = \underline{\quad}$

$8 + 5 = \underline{\quad}$

$\underline{\quad} + 3 = 11$

$7 + \underline{\quad} = 15$

$4 + \underline{\quad} = 13$

$\underline{\quad} + 7 = 16$

$7 + 6 = \underline{\quad}$

$3 + 9 = \underline{\quad}$

$9 + \underline{\quad} = 17$

$6 + 6 = \underline{\quad}$

$8 + \underline{\quad} = 16$

$\underline{\quad} + 9 = 15$

$9 + 6 = \underline{\quad}$

$2 + \underline{\quad} = 11$

$8 + \underline{\quad} = 14$

$\underline{\quad} + 7 = 14$

$\underline{\quad} + 9 = 16$

$9 + \underline{\quad} = 12$

$4 + \underline{\quad} = 11$

$8 + 4 = \underline{\quad}$

$6 + \underline{\quad} = 13$

$9 + \underline{\quad} = 13$



Dieses Material stammt von www.fraulocke-grundschultante.de
(Nicole Trapp)
Schriften: Frau Locke Schriftarten
erstellt mit dem Worksheet Crafter
Illustrationen: Worksheet Crafter

Hinweis:

Du darfst das vorliegende Material für **deinen Unterricht** verwenden. Du darfst es nicht gewerblich nutzen und du darfst es nicht über soziale Netzwerke, Dropbox und ähnliche Dienste verbreiten und weitergeben. Damit verletzt du das Urheberrecht. Wenn du einen solchen Verstoß bemerkst, melde ihn bitte an: mail@fraulocke-grundschultante.de

Ich freue mich sehr über Kommentare unter dem jeweiligen Beitrag oder im Gästebuch meiner Seite. Du kannst mich auch gerne auf Instagram verlinken: [fraulocke_grundschultante](https://www.instagram.com/fraulocke_grundschultante).

Viel Spaß mit dem Material!

Frau Locke

Name:

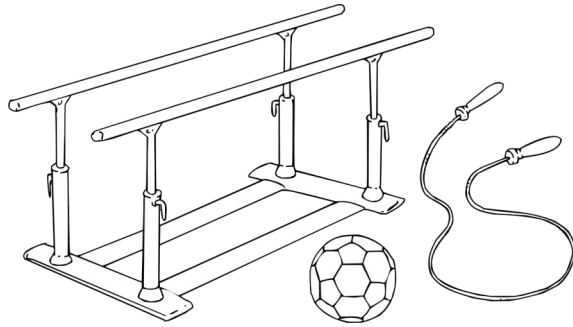
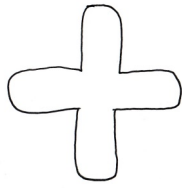

mit ZÜ!

Wir trainieren
plus bis 20

Frau Locke

Name:

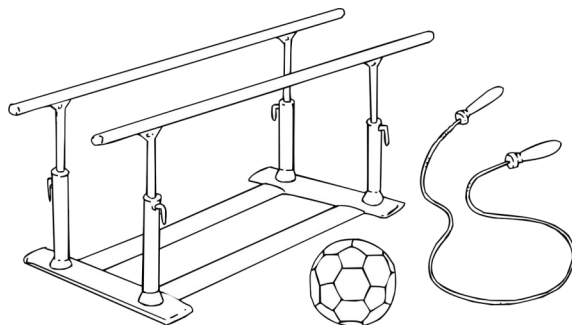
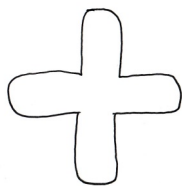

mit ZÜ!

Wir trainieren
plus bis 20

Frau Locke

$11 + 1 = \underline{12}$

$15 + 1 = \underline{16}$

$17 + 3 = \underline{20}$

$14 + 2 = \underline{16}$

$12 + 6 = \underline{18}$

$16 + 1 = \underline{17}$

$11 + 8 = \underline{19}$

$11 + 4 = \underline{15}$

$12 + 2 = \underline{14}$

$10 + 4 = \underline{14}$

$14 + 3 = \underline{17}$

$16 + 3 = \underline{19}$

$17 + 2 = \underline{19}$

$18 + 1 = \underline{19}$

$17 + 1 = \underline{18}$

$12 + 4 = \underline{16}$

$10 + 3 = \underline{13}$

$11 + 6 = \underline{17}$

$12 + 1 = \underline{13}$

$14 + 4 = \underline{18}$

$11 + 5 = \underline{16}$

$19 + 1 = \underline{20}$

$16 + 4 = \underline{20}$

$16 + 2 = \underline{18}$

$10 + 5 = \underline{15}$

$18 + 2 = \underline{20}$

$10 + 7 = \underline{17}$

$13 + 7 = \underline{20}$

$13 + 5 = \underline{18}$

$12 + 7 = \underline{19}$

$11 + 1 = \underline{12}$

$15 + 1 = \underline{16}$

$17 + 3 = \underline{20}$

$14 + 2 = \underline{16}$

$12 + 6 = \underline{18}$

$16 + 1 = \underline{17}$

$11 + 8 = \underline{19}$

$11 + 4 = \underline{15}$

$12 + 2 = \underline{14}$

$10 + 4 = \underline{14}$

$14 + 3 = \underline{17}$

$16 + 3 = \underline{19}$

$17 + 2 = \underline{19}$

$18 + 1 = \underline{19}$

$17 + 1 = \underline{18}$

$12 + 4 = \underline{16}$

$10 + 3 = \underline{13}$

$11 + 6 = \underline{17}$

$12 + 1 = \underline{13}$

$14 + 4 = \underline{18}$

$11 + 5 = \underline{16}$

$19 + 1 = \underline{20}$

$16 + 4 = \underline{20}$

$16 + 2 = \underline{18}$

$10 + 5 = \underline{15}$

$18 + 2 = \underline{20}$

$10 + 7 = \underline{17}$

$13 + 7 = \underline{20}$

$13 + 5 = \underline{18}$

$12 + 7 = \underline{19}$



$10 + 9 = \underline{19}$

$18 + 1 = \underline{19}$

$13 + 4 = \underline{17}$

$17 + 1 = \underline{18}$

$14 + 4 = \underline{18}$

$15 + 2 = \underline{17}$

$19 + 1 = \underline{20}$

$16 + 2 = \underline{18}$

$12 + 7 = \underline{19}$

$14 + 5 = \underline{19}$

$10 + 6 = \underline{16}$

$16 + 1 = \underline{17}$

$10 + 10 = \underline{20}$

$15 + 1 = \underline{16}$

$14 + 1 = \underline{15}$

$17 + 3 = \underline{20}$

$10 + 5 = \underline{15}$

$11 + 7 = \underline{18}$

$15 + 3 = \underline{18}$

$13 + 3 = \underline{16}$

$11 + 3 = \underline{14}$

$13 + 7 = \underline{20}$

$13 + 5 = \underline{18}$

$13 + 1 = \underline{14}$

$17 + 2 = \underline{19}$

$16 + 4 = \underline{20}$

$15 + 4 = \underline{19}$

$13 + 6 = \underline{19}$

$13 + 2 = \underline{15}$

$10 + 2 = \underline{12}$



$10 + 9 = \underline{19}$

$18 + 1 = \underline{19}$

$13 + 4 = \underline{17}$

$17 + 1 = \underline{18}$

$14 + 4 = \underline{18}$

$15 + 2 = \underline{17}$

$19 + 1 = \underline{20}$

$16 + 2 = \underline{18}$

$12 + 7 = \underline{19}$

$14 + 5 = \underline{19}$

$10 + 6 = \underline{16}$

$16 + 1 = \underline{17}$

$10 + 10 = \underline{20}$

$15 + 1 = \underline{16}$

$14 + 1 = \underline{15}$

$17 + 3 = \underline{20}$

$10 + 5 = \underline{15}$

$11 + 7 = \underline{18}$

$15 + 3 = \underline{18}$

$13 + 3 = \underline{16}$

$11 + 3 = \underline{14}$

$13 + 7 = \underline{20}$

$13 + 5 = \underline{18}$

$13 + 1 = \underline{14}$

$17 + 2 = \underline{19}$

$16 + 4 = \underline{20}$

$15 + 4 = \underline{19}$

$13 + 6 = \underline{19}$

$13 + 2 = \underline{15}$

$10 + 2 = \underline{12}$

$8 + 6 = \underline{14}$

$7 + 7 = \underline{14}$

$3 + 8 = \underline{11}$

$5 + 7 = \underline{12}$

$6 + 8 = \underline{14}$

$9 + 5 = \underline{14}$

$9 + 7 = \underline{16}$

$6 + 6 = \underline{12}$

$9 + 8 = \underline{17}$

$3 + 9 = \underline{12}$

$4 + 8 = \underline{12}$

$5 + 9 = \underline{14}$

$4 + 9 = \underline{13}$

$8 + 5 = \underline{13}$

$6 + 9 = \underline{15}$

$7 + 5 = \underline{12}$

$2 + 9 = \underline{11}$

$6 + 7 = \underline{13}$

$5 + 6 = \underline{11}$

$8 + 3 = \underline{11}$

$6 + 5 = \underline{11}$

$9 + 2 = \underline{11}$

$4 + 7 = \underline{11}$

$5 + 8 = \underline{13}$

$8 + 7 = \underline{15}$

$8 + 9 = \underline{17}$

$9 + 4 = \underline{13}$

$7 + 8 = \underline{15}$

$7 + 6 = \underline{13}$

$7 + 9 = \underline{16}$

$8 + 6 = \underline{14}$

$7 + 7 = \underline{14}$

$3 + 8 = \underline{11}$

$5 + 7 = \underline{12}$

$6 + 8 = \underline{14}$

$9 + 5 = \underline{14}$

$9 + 7 = \underline{16}$

$6 + 6 = \underline{12}$

$9 + 8 = \underline{17}$

$3 + 9 = \underline{12}$

$4 + 8 = \underline{12}$

$5 + 9 = \underline{14}$

$4 + 9 = \underline{13}$

$8 + 5 = \underline{13}$

$6 + 9 = \underline{15}$

$7 + 5 = \underline{12}$

$2 + 9 = \underline{11}$

$6 + 7 = \underline{13}$

$5 + 6 = \underline{11}$

$8 + 3 = \underline{11}$

$6 + 5 = \underline{11}$

$9 + 2 = \underline{11}$

$4 + 7 = \underline{11}$

$5 + 8 = \underline{13}$

$8 + 7 = \underline{15}$

$8 + 9 = \underline{17}$

$9 + 4 = \underline{13}$

$7 + 8 = \underline{15}$

$7 + 6 = \underline{13}$

$7 + 9 = \underline{16}$



$8 + 4 = \underline{12}$

$9 + 4 = \underline{13}$

$4 + 7 = \underline{11}$

$4 + 9 = \underline{13}$

$8 + 5 = \underline{13}$

$7 + 4 = \underline{11}$

$2 + 9 = \underline{11}$

$8 + 6 = \underline{14}$

$4 + 8 = \underline{12}$

$5 + 8 = \underline{13}$

$6 + 6 = \underline{12}$

$3 + 9 = \underline{12}$

$5 + 9 = \underline{14}$

$8 + 3 = \underline{11}$

$5 + 6 = \underline{11}$

$6 + 8 = \underline{14}$

$7 + 7 = \underline{14}$

$9 + 3 = \underline{12}$

$9 + 2 = \underline{11}$

$9 + 6 = \underline{15}$

$7 + 9 = \underline{16}$

$6 + 7 = \underline{13}$

$3 + 8 = \underline{11}$

$9 + 9 = \underline{18}$

$6 + 9 = \underline{15}$

$5 + 7 = \underline{12}$

$7 + 6 = \underline{13}$

$8 + 7 = \underline{15}$

$6 + 5 = \underline{11}$

$8 + 8 = \underline{16}$



$8 + 4 = \underline{12}$

$9 + 4 = \underline{13}$

$4 + 7 = \underline{11}$

$4 + 9 = \underline{13}$

$8 + 5 = \underline{13}$

$7 + 4 = \underline{11}$

$2 + 9 = \underline{11}$

$8 + 6 = \underline{14}$

$4 + 8 = \underline{12}$

$5 + 8 = \underline{13}$

$6 + 6 = \underline{12}$

$3 + 9 = \underline{12}$

$5 + 9 = \underline{14}$

$8 + 3 = \underline{11}$

$5 + 6 = \underline{11}$

$6 + 8 = \underline{14}$

$7 + 7 = \underline{14}$

$9 + 3 = \underline{12}$

$9 + 2 = \underline{11}$

$9 + 6 = \underline{15}$

$7 + 9 = \underline{16}$

$6 + 7 = \underline{13}$

$3 + 8 = \underline{11}$

$9 + 9 = \underline{18}$

$6 + 9 = \underline{15}$

$5 + 7 = \underline{12}$

$7 + 6 = \underline{13}$

$8 + 7 = \underline{15}$

$6 + 5 = \underline{11}$

$8 + 8 = \underline{16}$



$5 + 7 = \underline{12}$

$9 + 7 = \underline{16}$

$6 + 6 = \underline{12}$

$5 + 6 = \underline{11}$

$8 + 6 = \underline{14}$

$9 + 6 = \underline{15}$

$7 + 5 = \underline{12}$

$4 + 8 = \underline{12}$

$9 + 2 = \underline{11}$

$2 + 9 = \underline{11}$

$6 + 5 = \underline{11}$

$6 + 8 = \underline{14}$

$7 + 7 = \underline{14}$

$8 + 7 = \underline{15}$

$7 + 6 = \underline{13}$

$4 + 7 = \underline{11}$

$4 + 9 = \underline{13}$

$8 + 8 = \underline{16}$

$5 + 9 = \underline{14}$

$7 + 8 = \underline{15}$

$9 + 4 = \underline{13}$

$3 + 8 = \underline{11}$

$3 + 9 = \underline{12}$

$9 + 3 = \underline{12}$

$8 + 5 = \underline{13}$

$7 + 4 = \underline{11}$

$5 + 8 = \underline{13}$

$6 + 7 = \underline{13}$

$7 + 9 = \underline{16}$

$6 + 9 = \underline{15}$



$5 + 7 = \underline{12}$

$9 + 7 = \underline{16}$

$6 + 6 = \underline{12}$

$5 + 6 = \underline{11}$

$8 + 6 = \underline{14}$

$9 + 6 = \underline{15}$

$7 + 5 = \underline{12}$

$4 + 8 = \underline{12}$

$9 + 2 = \underline{11}$

$2 + 9 = \underline{11}$

$6 + 5 = \underline{11}$

$6 + 8 = \underline{14}$

$7 + 7 = \underline{14}$

$8 + 7 = \underline{15}$

$7 + 6 = \underline{13}$

$4 + 7 = \underline{11}$

$4 + 9 = \underline{13}$

$8 + 8 = \underline{16}$

$5 + 9 = \underline{14}$

$7 + 8 = \underline{15}$

$9 + 4 = \underline{13}$

$3 + 8 = \underline{11}$

$3 + 9 = \underline{12}$

$9 + 3 = \underline{12}$

$8 + 5 = \underline{13}$

$7 + 4 = \underline{11}$

$5 + 8 = \underline{13}$

$6 + 7 = \underline{13}$

$7 + 9 = \underline{16}$

$6 + 9 = \underline{15}$

$16 + 4 = \underline{20}$

$5 + 10 = \underline{15}$

$2 + 1 = \underline{3}$

$6 + 14 = \underline{20}$

$10 + 1 = \underline{11}$

$1 + 8 = \underline{9}$

$4 + 3 = \underline{7}$

$14 + 5 = \underline{19}$

$13 + 4 = \underline{17}$

$11 + 6 = \underline{17}$

$12 + 6 = \underline{18}$

$13 + 1 = \underline{14}$

$2 + 13 = \underline{15}$

$11 + 5 = \underline{16}$

$9 + 4 = \underline{13}$

$17 + 2 = \underline{19}$

$2 + 18 = \underline{20}$

$2 + 7 = \underline{9}$

$15 + 2 = \underline{17}$

$16 + 2 = \underline{18}$

$8 + 3 = \underline{11}$

$9 + 2 = \underline{11}$

$17 + 1 = \underline{18}$

$3 + 7 = \underline{10}$

$13 + 5 = \underline{18}$

$14 + 1 = \underline{15}$

$4 + 12 = \underline{16}$

$1 + 4 = \underline{5}$

$7 + 6 = \underline{13}$

$2 + 10 = \underline{12}$

$16 + 4 = \underline{20}$

$5 + 10 = \underline{15}$

$2 + 1 = \underline{3}$

$6 + 14 = \underline{20}$

$10 + 1 = \underline{11}$

$1 + 8 = \underline{9}$

$4 + 3 = \underline{7}$

$14 + 5 = \underline{19}$

$13 + 4 = \underline{17}$

$11 + 6 = \underline{17}$

$12 + 6 = \underline{18}$

$13 + 1 = \underline{14}$

$2 + 13 = \underline{15}$

$11 + 5 = \underline{16}$

$9 + 4 = \underline{13}$

$17 + 2 = \underline{19}$

$2 + 18 = \underline{20}$

$2 + 7 = \underline{9}$

$15 + 2 = \underline{17}$

$16 + 2 = \underline{18}$

$8 + 3 = \underline{11}$

$9 + 2 = \underline{11}$

$17 + 1 = \underline{18}$

$3 + 7 = \underline{10}$

$13 + 5 = \underline{18}$

$14 + 1 = \underline{15}$

$4 + 12 = \underline{16}$

$1 + 4 = \underline{5}$

$7 + 6 = \underline{13}$

$2 + 10 = \underline{12}$





$2 + 13 = \underline{15}$	$4 + 1 = \underline{5}$	$1 + 12 = \underline{13}$
$12 + 4 = \underline{16}$	$1 + 10 = \underline{11}$	$13 + 6 = \underline{19}$
$16 + 2 = \underline{18}$	$11 + 7 = \underline{18}$	$10 + 1 = \underline{11}$
$2 + 3 = \underline{5}$	$7 + 13 = \underline{20}$	$6 + 10 = \underline{16}$
$9 + 8 = \underline{17}$	$2 + 18 = \underline{20}$	$3 + 1 = \underline{4}$
$12 + 3 = \underline{15}$	$2 + 17 = \underline{19}$	$5 + 14 = \underline{19}$
$11 + 6 = \underline{17}$	$6 + 5 = \underline{11}$	$16 + 1 = \underline{17}$
$10 + 10 = \underline{20}$	$12 + 2 = \underline{14}$	$3 + 17 = \underline{20}$
$17 + 2 = \underline{19}$	$14 + 1 = \underline{15}$	$15 + 2 = \underline{17}$
$17 + 1 = \underline{18}$	$3 + 14 = \underline{17}$	$12 + 5 = \underline{17}$

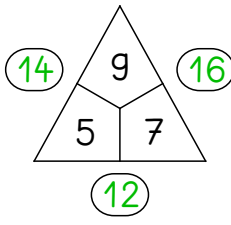
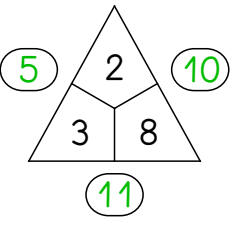
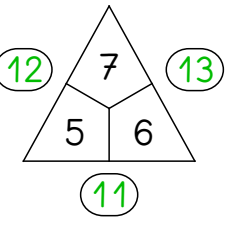
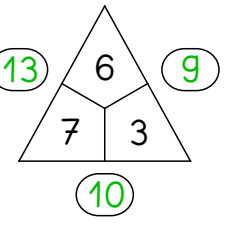
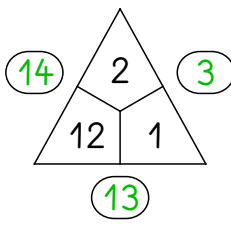
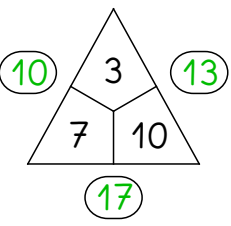
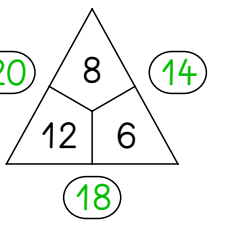
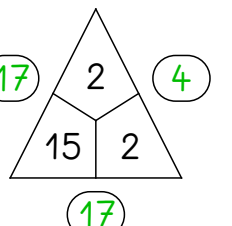
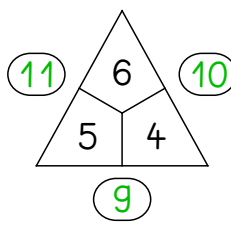
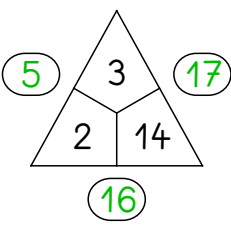
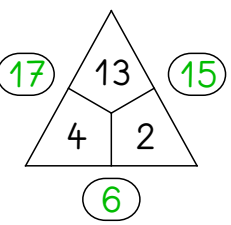
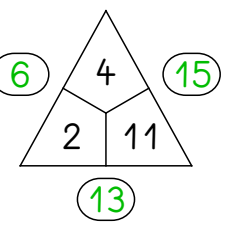
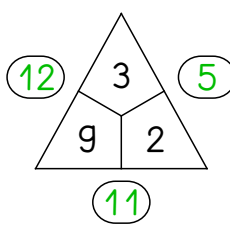
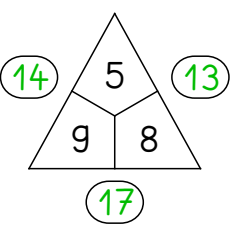
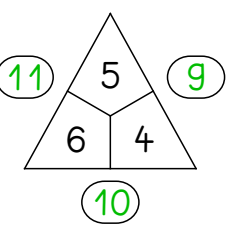
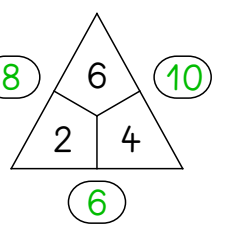

$2 + 13 = \underline{15}$	$4 + 1 = \underline{5}$	$1 + 12 = \underline{13}$
$12 + 4 = \underline{16}$	$1 + 10 = \underline{11}$	$13 + 6 = \underline{19}$
$16 + 2 = \underline{18}$	$11 + 7 = \underline{18}$	$10 + 1 = \underline{11}$
$2 + 3 = \underline{5}$	$7 + 13 = \underline{20}$	$6 + 10 = \underline{16}$
$9 + 8 = \underline{17}$	$2 + 18 = \underline{20}$	$3 + 1 = \underline{4}$
$12 + 3 = \underline{15}$	$2 + 17 = \underline{19}$	$5 + 14 = \underline{19}$
$11 + 6 = \underline{17}$	$6 + 5 = \underline{11}$	$16 + 1 = \underline{17}$
$10 + 10 = \underline{20}$	$12 + 2 = \underline{14}$	$3 + 17 = \underline{20}$
$17 + 2 = \underline{19}$	$14 + 1 = \underline{15}$	$15 + 2 = \underline{17}$
$17 + 1 = \underline{18}$	$3 + 14 = \underline{17}$	$12 + 5 = \underline{17}$

8 

8 

9

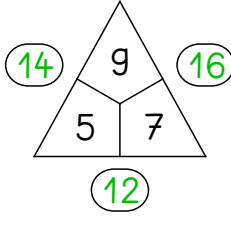
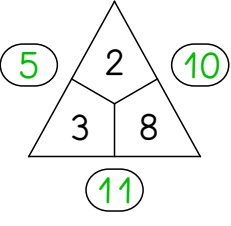
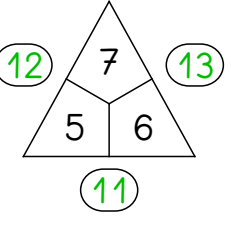
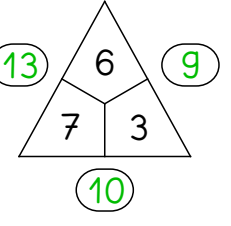
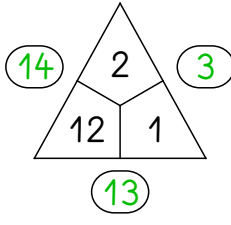
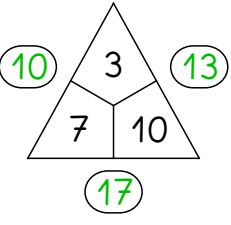
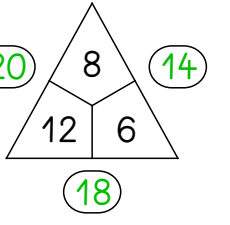
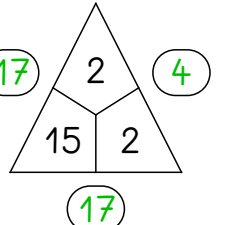
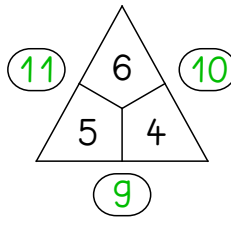
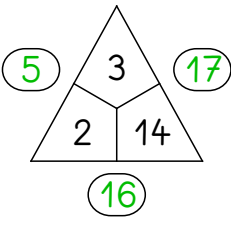
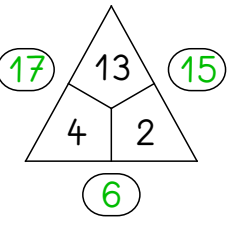
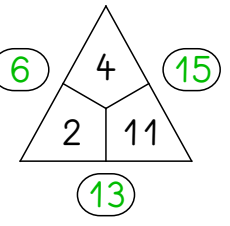
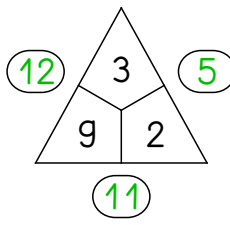
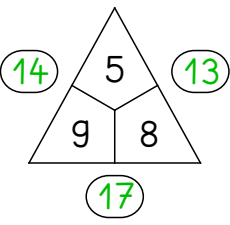
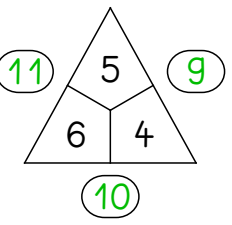
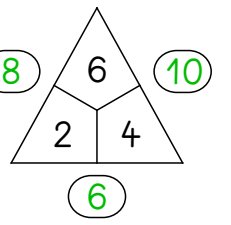

+	11	7	5	6	2
3	14	10	8	9	5
9	20	16	14	15	11
2	13	9	7	8	4

+	6	8	7	3	2
12	18	20	19	15	14
5	11	13	12	8	7
2	8	10	9	5	4

+	3	2	6	5	7
11	14	13	17	16	18
5	8	7	11	10	12
2	5	4	8	7	9
13	16	15	19	18	20
8	11	10	14	13	15

+	3	6	9	7	5
1	4	7	10	8	6
10	13	16	19	17	15
7	10	13	16	14	12

9



+	11	7	5	6	2
3	14	10	8	9	5
9	20	16	14	15	11
2	13	9	7	8	4

+	6	8	7	3	2
12	18	20	19	15	14
5	11	13	12	8	7
2	8	10	9	5	4

+	3	2	6	5	7
11	14	13	17	16	18
5	8	7	11	10	12
2	5	4	8	7	9
13	16	15	19	18	20
8	11	10	14	13	15

+	3	6	9	7	5
1	4	7	10	8	6
10	13	16	19	17	15
7	10	13	16	14	12

15 6 9 3 3 6	18 8 10 7 1 9	14 6 8 2 4 4	
16 5 11 2 3 8	11 7 4 5 2 2	12 4 8 1 3 5	20 8 12 2 6 6
19 13 6 9 4 2	18 10 8 6 4 4	13 6 7 2 4 3	18 8 10 4 4 6
14 8 6 8 0 6	11 6 5 6 0 5	12 2 10 2 0 10	17 9 8 3 6 2

15 6 9 3 3 6	18 8 10 7 1 9	14 6 8 2 4 4	
16 5 11 2 3 8	11 7 4 5 2 2	12 4 8 1 3 5	20 8 12 2 6 6
19 13 6 9 4 2	18 10 8 6 4 4	13 6 7 2 4 3	18 8 10 4 4 6
14 8 6 8 0 6	11 6 5 6 0 5	12 2 10 2 0 10	17 9 8 3 6 2

11 

4	7
8	3
11	0
7	4
9	2
0	11
10	1
1	10
6	5
2	9

3	10
10	3
1	12
2	11
6	7
8	5
4	9
0	13
13	0
7	6

1	15
15	1
7	9
5	11
8	8
16	0
4	12
14	2
2	14
6	10

15	4
1	18
6	13
14	5
9	10
17	2
5	14
12	7
11	8
7	12

17	3
15	5
12	8
8	12
0	20
10	10
18	2
20	0
4	16
14	6

11 

4	7
8	3
11	0
7	4
9	2
0	11
10	1
1	10
6	5
2	9

3	10
10	3
1	12
2	11
6	7
8	5
4	9
0	13
13	0
7	6

1	15
15	1
7	9
5	11
8	8
16	0
4	12
14	2
2	14
6	10

15	4
1	18
6	13
14	5
9	10
17	2
5	14
12	7
11	8
7	12

17	3
15	5
12	8
8	12
0	20
10	10
18	2
20	0
4	16
14	6



$18 + \underline{2} = 20$

$12 + \underline{6} = 18$

$10 + \underline{5} = 15$

$10 + \underline{8} = 18$

$17 + \underline{1} = 18$

$18 + \underline{1} = 19$

$17 + \underline{3} = 20$

$17 + \underline{2} = 19$

$12 + \underline{4} = 16$

$10 + \underline{7} = 17$

$11 + \underline{9} = 20$

$15 + \underline{1} = 16$

$15 + \underline{4} = 19$

$13 + \underline{4} = 17$

$16 + \underline{3} = 19$

$11 + \underline{4} = 15$

$11 + \underline{2} = 13$

$15 + \underline{5} = 20$

$19 + \underline{1} = 20$

$11 + \underline{3} = 14$

$14 + \underline{1} = 15$

$10 + \underline{2} = 12$

$15 + \underline{2} = 17$

$12 + \underline{2} = 14$

$15 + \underline{3} = 18$

$13 + \underline{5} = 18$

$16 + \underline{4} = 20$

$13 + \underline{2} = 15$

$14 + \underline{6} = 20$

$13 + \underline{7} = 20$



$18 + \underline{2} = 20$

$12 + \underline{6} = 18$

$10 + \underline{5} = 15$

$10 + \underline{8} = 18$

$17 + \underline{1} = 18$

$18 + \underline{1} = 19$

$17 + \underline{3} = 20$

$17 + \underline{2} = 19$

$12 + \underline{4} = 16$

$10 + \underline{7} = 17$

$11 + \underline{9} = 20$

$15 + \underline{1} = 16$

$15 + \underline{4} = 19$

$13 + \underline{4} = 17$

$16 + \underline{3} = 19$

$11 + \underline{4} = 15$

$11 + \underline{2} = 13$

$15 + \underline{5} = 20$

$19 + \underline{1} = 20$

$11 + \underline{3} = 14$

$14 + \underline{1} = 15$

$10 + \underline{2} = 12$

$15 + \underline{2} = 17$

$12 + \underline{2} = 14$

$15 + \underline{3} = 18$

$13 + \underline{5} = 18$

$16 + \underline{4} = 20$

$13 + \underline{2} = 15$

$14 + \underline{6} = 20$

$13 + \underline{7} = 20$

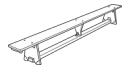

$8 + \underline{9} = 17$

$8 + \underline{5} = 13$

$9 + \underline{5} = 14$

$5 + \underline{7} = 12$

$9 + \underline{3} = 12$

$8 + \underline{3} = 11$

$2 + \underline{9} = 11$

$3 + \underline{8} = 11$

$9 + \underline{2} = 11$

$4 + \underline{7} = 11$

$6 + \underline{7} = 13$

$7 + \underline{7} = 14$

$4 + \underline{8} = 12$

$4 + \underline{9} = 13$

$9 + \underline{9} = 18$

$6 + \underline{5} = 11$

$7 + \underline{8} = 15$

$8 + \underline{7} = 15$

$8 + \underline{6} = 14$

$7 + \underline{6} = 13$

$5 + \underline{6} = 11$

$3 + \underline{9} = 12$

$6 + \underline{8} = 14$

$8 + \underline{4} = 12$

$5 + \underline{9} = 14$

$7 + \underline{9} = 16$

$7 + \underline{4} = 11$

$6 + \underline{9} = 15$

$9 + \underline{7} = 16$

$5 + \underline{8} = 13$

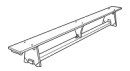

$8 + \underline{9} = 17$

$8 + \underline{5} = 13$

$9 + \underline{5} = 14$

$5 + \underline{7} = 12$

$9 + \underline{3} = 12$

$8 + \underline{3} = 11$

$2 + \underline{9} = 11$

$3 + \underline{8} = 11$

$9 + \underline{2} = 11$

$4 + \underline{7} = 11$

$6 + \underline{7} = 13$

$7 + \underline{7} = 14$

$4 + \underline{8} = 12$

$4 + \underline{9} = 13$

$9 + \underline{9} = 18$

$6 + \underline{5} = 11$

$7 + \underline{8} = 15$

$8 + \underline{7} = 15$

$8 + \underline{6} = 14$

$7 + \underline{6} = 13$

$5 + \underline{6} = 11$

$3 + \underline{9} = 12$

$6 + \underline{8} = 14$

$8 + \underline{4} = 12$

$5 + \underline{9} = 14$

$7 + \underline{9} = 16$

$7 + \underline{4} = 11$

$6 + \underline{9} = 15$

$9 + \underline{7} = 16$

$5 + \underline{8} = 13$



$12 + 5 = \underline{17}$

$18 + 1 = \underline{19}$

$12 + 6 = \underline{18}$

$\underline{11} + 7 = 18$

$\underline{14} + 4 = 18$

$15 + 2 = \underline{17}$

$17 + \underline{1} = 18$

$17 + \underline{3} = 20$

$\underline{12} + 7 = 19$

$19 + \underline{1} = 20$

$13 + 5 = \underline{18}$

$13 + \underline{3} = 16$

$12 + \underline{1} = 13$

$15 + 5 = \underline{20}$

$13 + \underline{7} = 20$

$\underline{10} + 6 = 16$

$\underline{16} + 4 = 20$

$15 + 1 = \underline{16}$

$\underline{15} + 4 = 19$

$14 + \underline{5} = 19$

$12 + 4 = \underline{16}$

$10 + \underline{7} = 17$

$\underline{10} + 1 = 11$

$12 + \underline{2} = 14$

$\underline{16} + 1 = 17$

$18 + 2 = \underline{20}$

$\underline{11} + 3 = 14$

$\underline{14} + 6 = 20$

$14 + \underline{2} = 16$

$15 + 3 = \underline{18}$

$10 + 3 = \underline{13}$

$\underline{10} + 4 = 14$

$\underline{14} + 3 = 17$



$12 + 5 = \underline{17}$

$18 + 1 = \underline{19}$

$12 + 6 = \underline{18}$

$\underline{11} + 7 = 18$

$\underline{14} + 4 = 18$

$15 + 2 = \underline{17}$

$17 + \underline{1} = 18$

$17 + \underline{3} = 20$

$\underline{12} + 7 = 19$

$19 + \underline{1} = 20$

$13 + 5 = \underline{18}$

$13 + \underline{3} = 16$

$12 + \underline{1} = 13$

$15 + 5 = \underline{20}$

$13 + \underline{7} = 20$

$\underline{10} + 6 = 16$

$\underline{16} + 4 = 20$

$15 + 1 = \underline{16}$

$\underline{15} + 4 = 19$

$14 + \underline{5} = 19$

$12 + 4 = \underline{16}$

$10 + \underline{7} = 17$

$\underline{10} + 1 = 11$

$12 + \underline{2} = 14$

$\underline{16} + 1 = 17$

$18 + 2 = \underline{20}$

$\underline{11} + 3 = 14$

$\underline{14} + 6 = 20$

$14 + \underline{2} = 16$

$15 + 3 = \underline{18}$

$10 + 3 = \underline{13}$

$\underline{10} + 4 = 14$

$\underline{14} + 3 = 17$

15



$3 + 8 = \underline{11}$

$\underline{9} + 5 = 14$

$9 + \underline{2} = 11$

$4 + 8 = \underline{12}$

$5 + 6 = \underline{11}$

$\underline{5} + 9 = 14$

$\underline{7} + 4 = 11$

$9 + \underline{9} = 18$

$6 + 5 = \underline{11}$

$8 + 5 = \underline{13}$

$\underline{8} + 3 = 11$

$7 + \underline{8} = 15$

$4 + \underline{9} = 13$

$\underline{9} + 7 = 16$

$7 + 6 = \underline{13}$

$3 + 9 = \underline{12}$

$9 + \underline{8} = 17$

$6 + 6 = \underline{12}$

$8 + \underline{8} = 16$

$\underline{6} + 9 = 15$

$9 + 6 = \underline{15}$

$2 + \underline{9} = 11$

$8 + \underline{6} = 14$

$\underline{7} + 7 = 14$

$\underline{7} + 9 = 16$

$9 + \underline{3} = 12$

$4 + \underline{7} = 11$

$8 + 4 = \underline{12}$

$6 + \underline{7} = 13$

$9 + \underline{4} = 13$

15



$3 + 8 = \underline{11}$

$\underline{9} + 5 = 14$

$9 + \underline{2} = 11$

$4 + 8 = \underline{12}$

$5 + 6 = \underline{11}$

$\underline{5} + 9 = 14$

$\underline{7} + 4 = 11$

$9 + \underline{9} = 18$

$6 + 5 = \underline{11}$

$8 + 5 = \underline{13}$

$\underline{8} + 3 = 11$

$7 + \underline{8} = 15$

$4 + \underline{9} = 13$

$\underline{9} + 7 = 16$

$7 + 6 = \underline{13}$

$3 + 9 = \underline{12}$

$9 + \underline{8} = 17$

$6 + 6 = \underline{12}$

$8 + \underline{8} = 16$

$\underline{6} + 9 = 15$

$9 + 6 = \underline{15}$

$2 + \underline{9} = 11$

$8 + \underline{6} = 14$

$\underline{7} + 7 = 14$

$\underline{7} + 9 = 16$

$9 + \underline{3} = 12$

$4 + \underline{7} = 11$

$8 + 4 = \underline{12}$

$6 + \underline{7} = 13$

$9 + \underline{4} = 13$



Dieses Material stammt von www.fraulocke-grundschultante.de
(Nicole Trapp)
Schriften: Frau Locke Schriftarten
erstellt mit dem Worksheet Crafter
Illustrationen: Worksheet Crafter

Hinweis:

Du darfst das vorliegende Material für **deinen Unterricht** verwenden. Du darfst es nicht gewerblich nutzen und du darfst es nicht über soziale Netzwerke, Dropbox und ähnliche Dienste verbreiten und weitergeben. Damit verletzt du das Urheberrecht. Wenn du einen solchen Verstoß bemerkst, melde ihn bitte an: mail@fraulocke-grundschultante.de

Ich freue mich sehr über Kommentare unter dem jeweiligen Beitrag oder im Gästebuch meiner Seite. Du kannst mich auch gerne auf Instagram verlinken: [fraulocke_grundschultante](https://www.instagram.com/fraulocke_grundschultante).

Viel Spaß mit dem Material!

Frau Locke